

Regulatory Requirements for Evaluation of Thyroid Status

Sue Marty, Ph.D., D.A.B.T.

The Dow Chemical Company

MSMarty@dow.com

HESI Workshop on Thyroid Hormone Assessment: Implications for Devtl and Repro Toxicology

9 May 2019

Agenda

- Species for thyroid evaluations in regulatory studies
- Regulatory studies in rats with thyroid endpoints
 - Study designs
 - Potential evaluation across ages
 - Methods to evaluate thyroid tissue
 - Evaluating thyroid hormone
 - Points to consider
 - Sources of variability
 - Best practices
- Conclusions

Thyroid Assessments: Rat is Primary Species

- Thyroid endpoints can be assessed in different species
 - Dog
 - Mouse
 - Amphibian
 - Fish (under consideration)
- Data from different species are useful for 'weight of evidence'
 - Consider differences in exposure route
- Focus in this presentation: Rats (especially DART-related studies)

Regulatory Studies Requiring Thyroid Assessments in Rats

Test Document	Title	Timing: Thyroid Endpoints
OECD 408	Repeated Dose 90-day Oral Toxicity Study	Termination: T3, T4, TSH, LDL/HDL, Total Cholesterol, Weight, Histo
OECD TG 414	Prenatal Developmental Toxicity Study	GD 20/21: T3, T4, TSH, Weight, Histo (Maternal)
OECD TG 421	Reproduction/Developmental Toxicity Screening Test	Parental males/PND 13 pups (LD 13 dams/PND 4 pups "If Relevant"): T4, TSH ("IR"), Histo (421: "IR"; 422: n=5/sex in adults, pups/remaining adults "IR")
OECD TG 422	Combined Repeated Dose Toxicity Study with the Reproduction/Developmental Toxicity Screening Test	
OECD TG 443	Extended One-Generation Reproductive Toxicity Study (EOGRTS)	Termination (P1/F1 - Cohort 1A): T4, TSH, Weight, Histo PND 4 (culled): T4 (optional) PND 22 (surplus): T4, TSH
OCSP 870.1450	Pubertal Development and Thyroid Function in Intact Juvenile/Peripubertal Female Rats	PND 42: T4, TSH, Weight, Histo
OSCP 870.1500	Pubertal Development and Thyroid Function in Intact Juvenile/Peripubertal Male Rats	PND 53: T4, TSH, Weight, Histo
EPA Guidance (OPP)	Comparative Thyroid Assay (CTA)	GD 20 Dams/Fetuses; LD 21 Dams/Pups: T3, T4, TSH, Weight, Histo

Thyroid endpoints optional in OECD 407 Repeated Dose 28-day Oral Toxicity Study

Developmental Toxicity Study Design

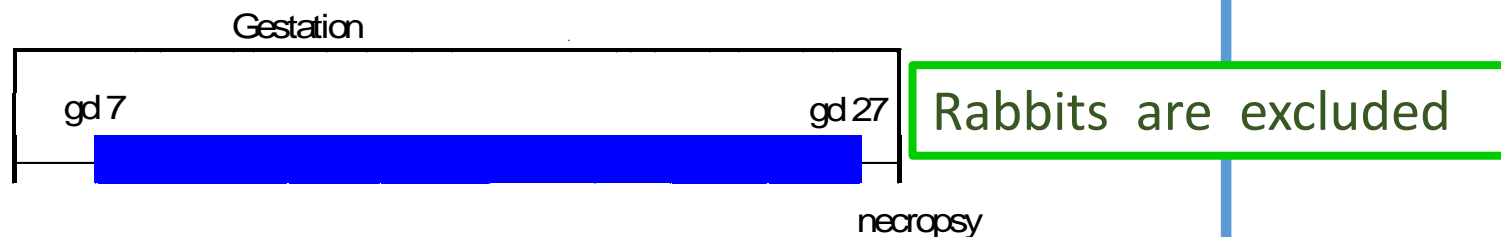
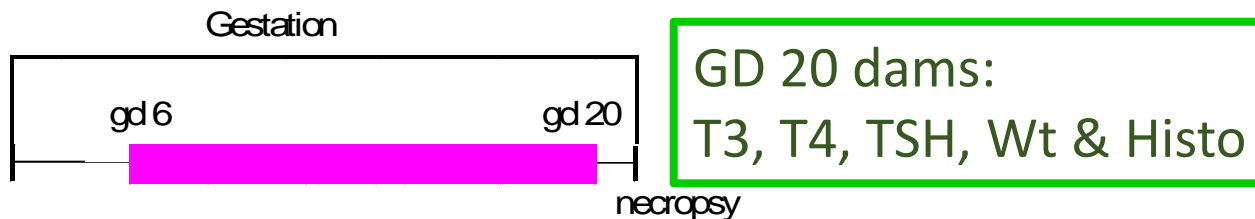

KEY

gd = gestation day

-  Gavage exposure period in rats
-  Gavage exposure period in rabbits

Experimental Animals:

N = (25 females/group) X 4 dose groups = 100 females/study

Offspring: ~1400 rat fetuses/study
~700 rabbit fetuses/study

Endpoints: Maternal food consumption, body weights, body weight gains, organ weights, pregnancy status, gravid uterine weight, corpora lutea number, live and dead embryos/fetuses, fetal sex and body weight, and alterations in fetal external, visceral and skeletal structures.

OECD 421/422: Thyroid Endpoints

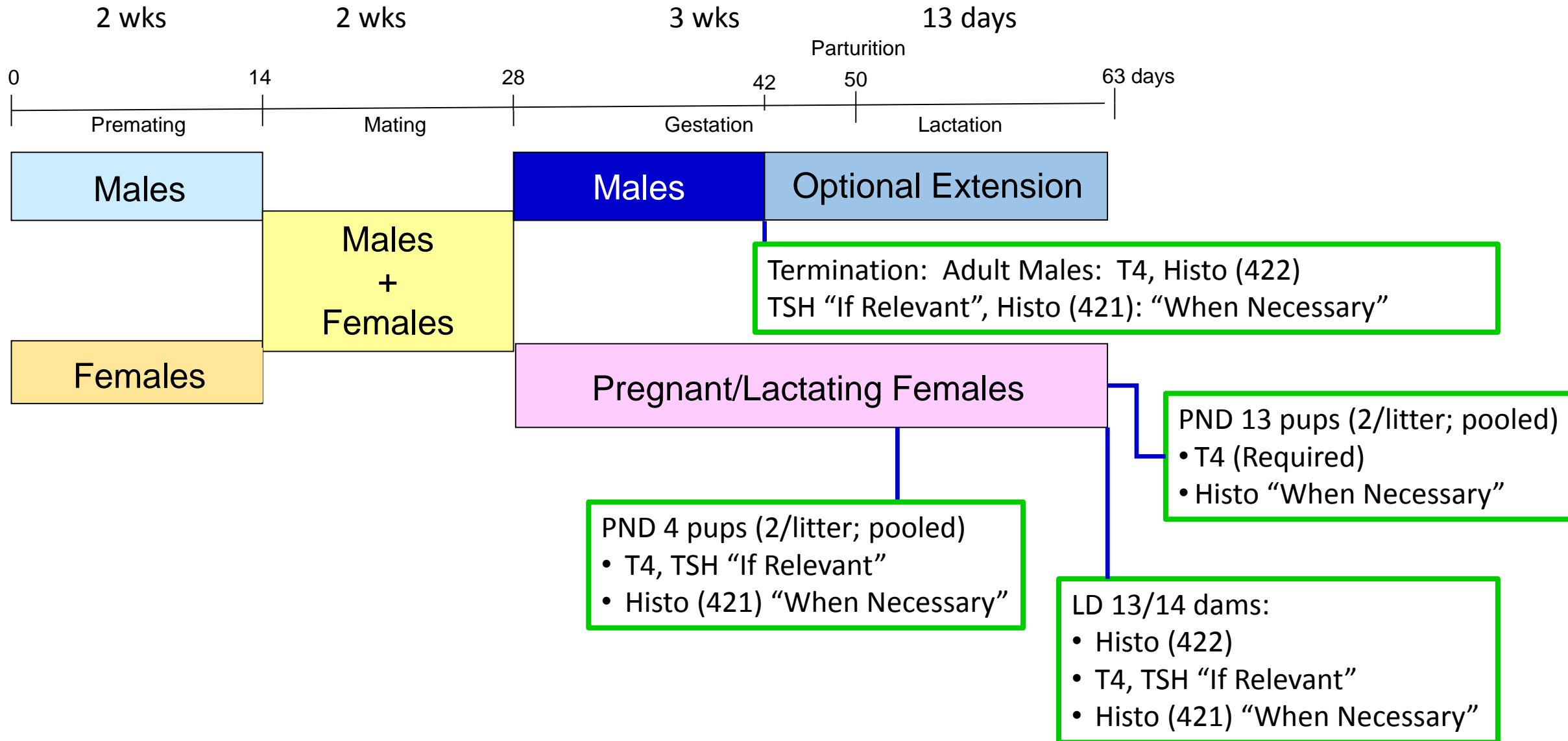

Pubertal Assays OPPTS 890.1450 and 890.1500: Focus on Thyroid Endpoints

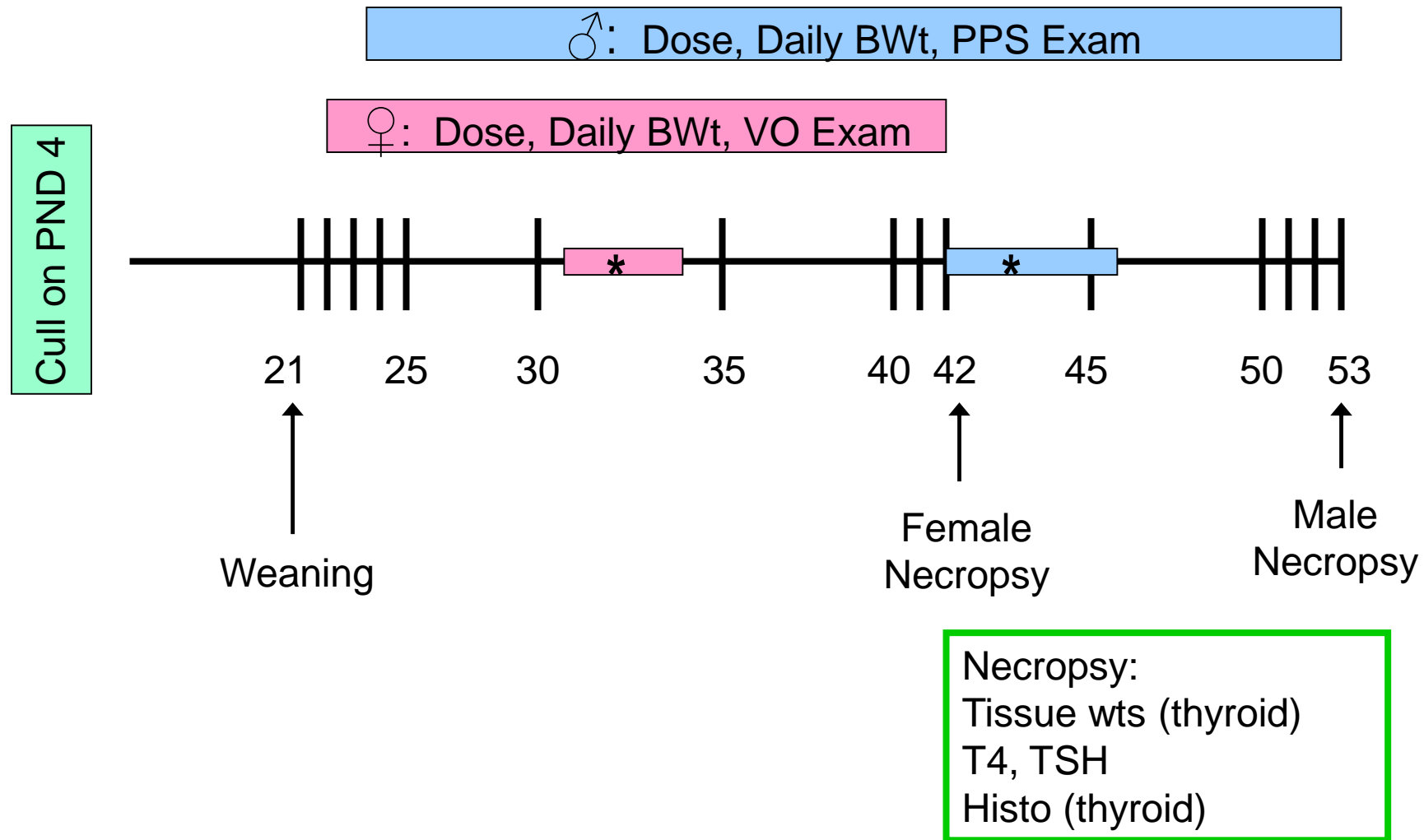

* Avg age at VO = 33.4 (31.6-35.1) – After VO, evaluate estrous cycle
Avg age at PPS = 43.6 (41.8-45.9)

Extended One-Generation Study

♂, ♀: Cageside/Clin. Obs.
 Body Weight
 Feed Consumption
 Detailed Clinical Obs.
 ♀: Estrous Cycle (2 wks; pre mating)

**P♂ & P♀ : clin path/thyroid hormones, urinalysis,
 Repro and target organ wts and histopathology**

♂, ♀: Organ Weights
 Histopathology
 ♂: Sperm Analysis
 Motility
 Morphology
 Epididymal Counts
 ♀: Qual. Ovarian Staging

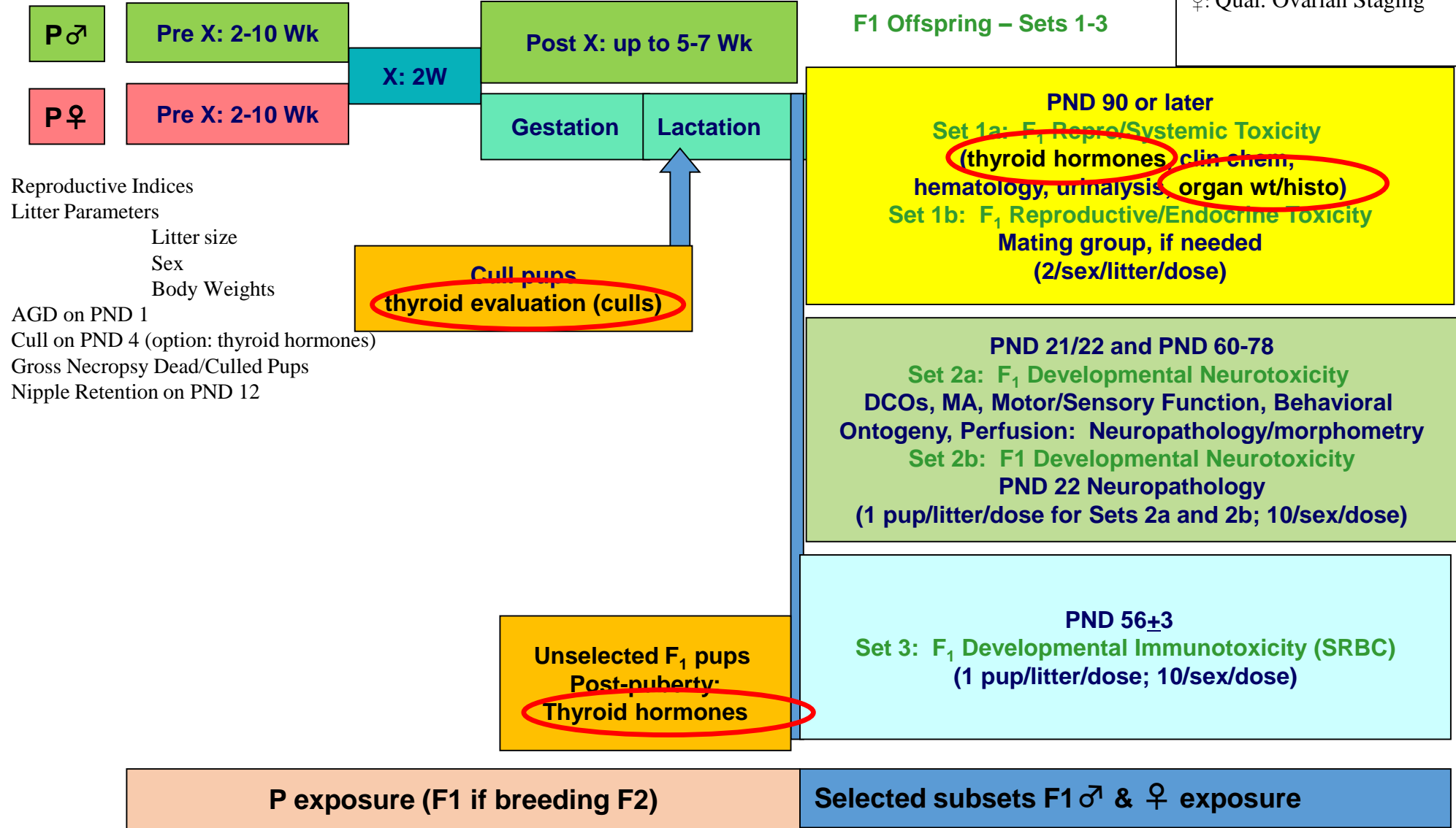

Comparative Thyroid Study (OPPTS)

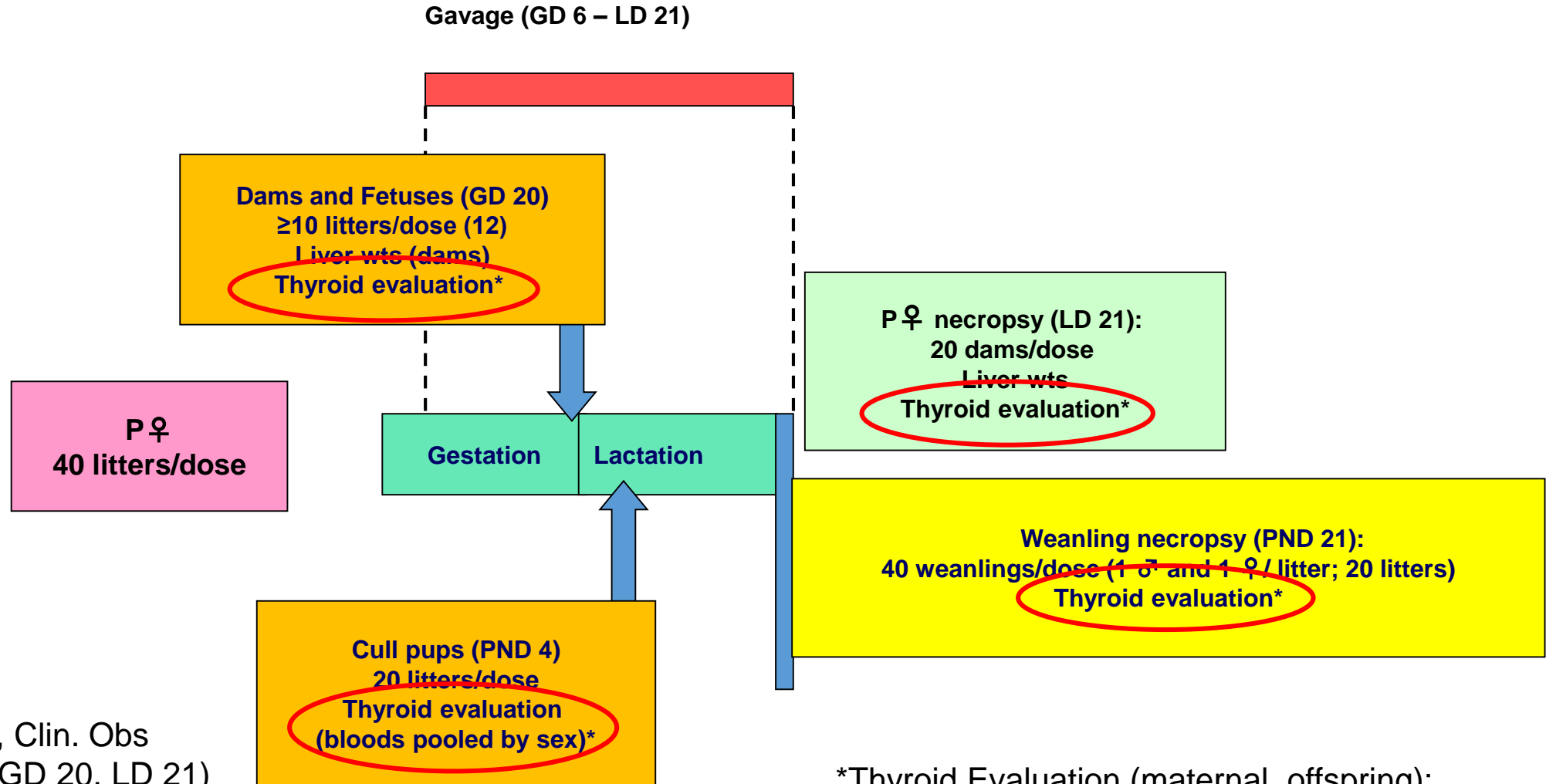

Endpoints:

- Maternal Bwts, FC, Clin. Obs
- Litter Parameters (GD 20, LD 21)
- Fetal Sex, Bwts, External Exams
- Litter Sizes
- Pup Bwts
- Gross Necropsy Obs.

*Thyroid Evaluation (maternal, offspring):

- T3, T4, TSH Levels
- Thyroid Weights
- Thyroid Histopathology (1 ♂ and 1 ♀/litter)

Thyroid Hormone Assessments Across Ages in Regulatory Studies

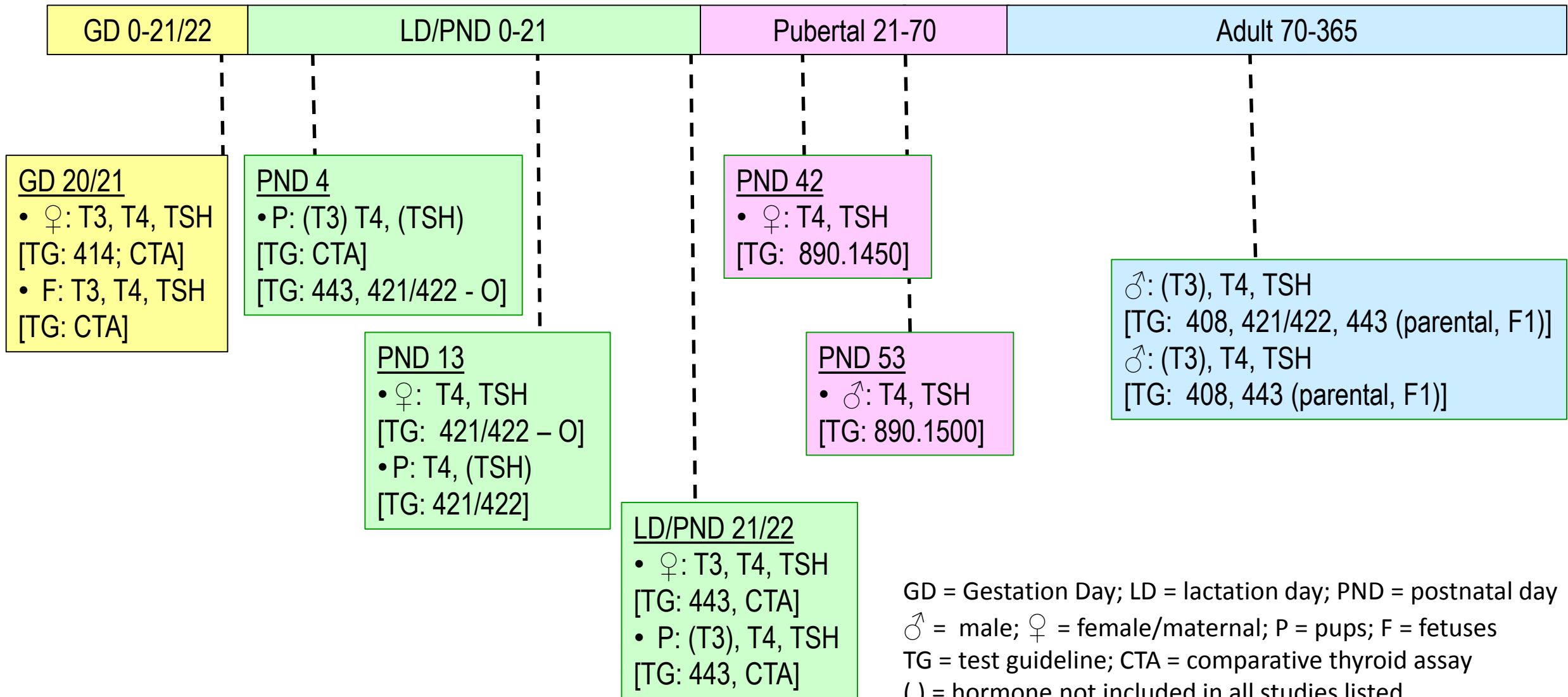

GD = Gestation Day; LD = lactation day; PND = postnatal day
 ♂ = male; ♀ = female/maternal; P = pups; F = fetuses
 TG = test guideline; CTA = comparative thyroid assay
 () = hormone not included in all studies listed
 O = optional sampling

Thyroid Wts & Histo Assessments Across Ages in Regulatory Studies

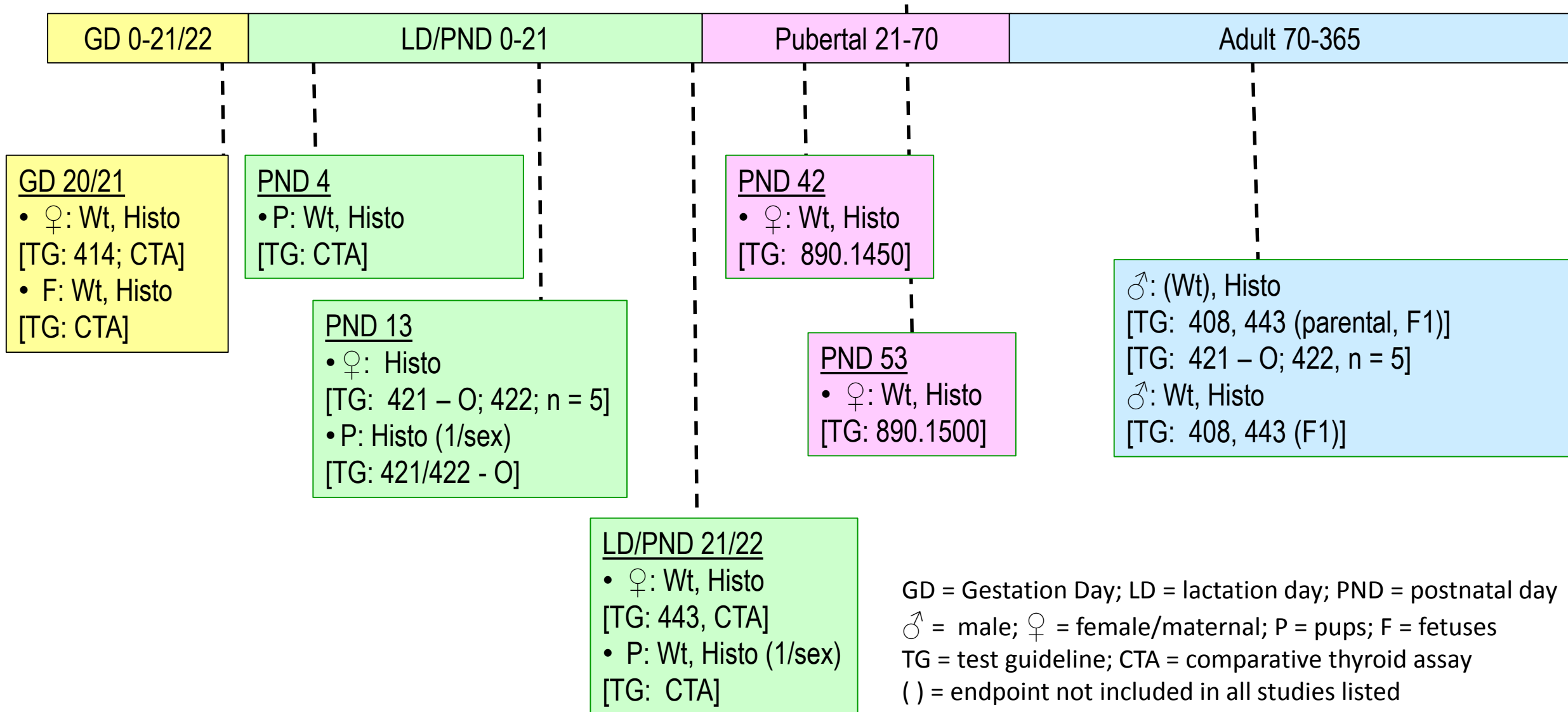

GD = Gestation Day; LD = lactation day; PND = postnatal day
 ♂ = male; ♀ = female/maternal; P = pups; F = fetuses
 TG = test guideline; CTA = comparative thyroid assay
 () = endpoint not included in all studies listed
 O = optional sampling

Methods to Evaluate Thyroid Endpoints: Thyroid Tissue

- Thyroid weights
 - Fresh or fixed
 - Tissue is fragile and small, particularly fetuses/pups
 - Accurate weight: Microscopic dissection (resource intensive)
 - Thyroid weights may be insensitive in young animals
- Thyroid histopathology
 - Some variability across thyroid lobes
 - Morphological scoring is generally not needed to identify effects

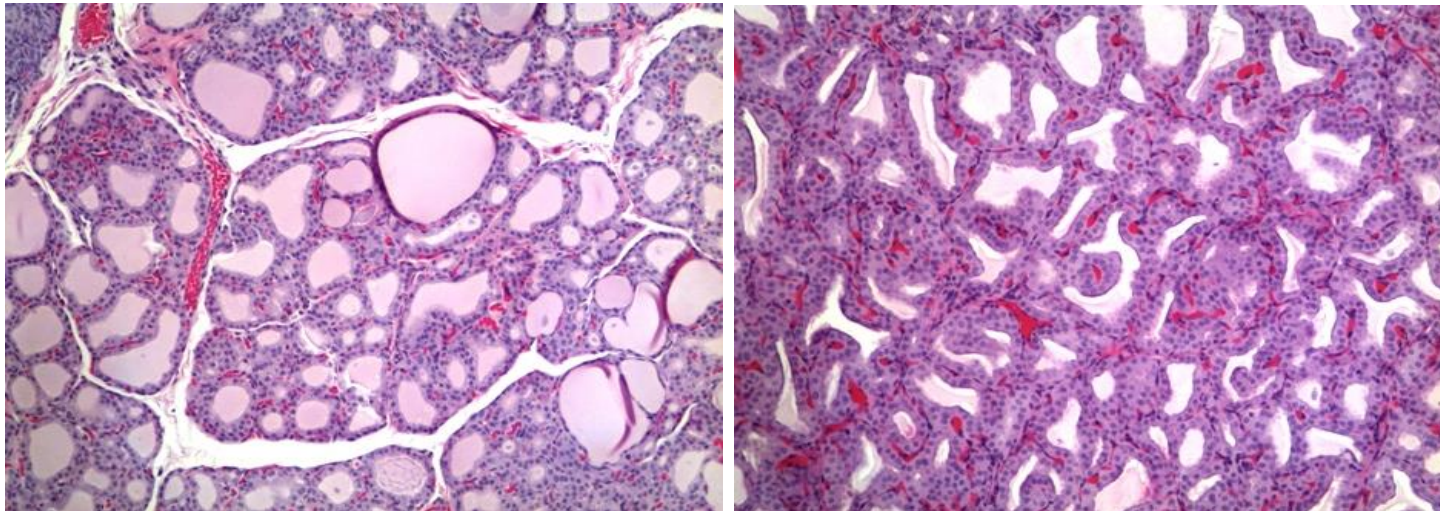

Evaluating Thyroid Endpoints: Thyroid Hormones

- Regulatory studies with TH assessments in gestational or pre-weaning animals
 - Susceptible life stages for thyroid insufficiency (neurodevelopment)
 - Developmental ontogeny of TH synthesis/release (Li *et al.*, 2019)
 - Term fetus: Maternal TH contributes 17.5% T4 and 47% T3
 - PND 4: Low serum T4 (0.5 – 1.0 µg/dl)
 - PND 13: Near peak serum T4 (8 – 12 µg/dl on PND 15)
 - PND 21: Comparable to adult T4 levels (3-4 µg/dl)
- For adequate sample volume, pool blood by litter In young animals (e.g., fetuses, PND 4)
 - Sex-specific differences in TH not expected
- T3 and T4 are conserved across species, but TSH is species-specific

Variability in Thyroid Hormone Measurements

- Biological variance
- Physiological: Differences in test animals (e.g., age, sex, strain, diet, fasted condition, stress, time of sample collection)
- Procedural: Parameters for sample collection (e.g., blood collection method, anesthesia), quantitative differences in hormone methodologies
 - Necropsy in different room from animal holding area (moved well before necropsy)
 - Balancing time of sample collection across groups with completion before 1300 h
 - Anesthesia – expectation in EU
 - Volume limitations
 - Method sensitivity (especially fetuses and PND 4 pups)
- Impact of many of these parameters on variability has not been systematically evaluated
 - Comparisons across labs may be difficult

T3, T4, TSH Variability Similar Across Ages

Li *et al.*, 2019 compared data across 8 laboratories

- Limited data sets
- A subset of T4 data shown in Figure 7
- Greatest variance contributed by lab/methodology
- When compared within a lab, CVs for rat fetuses and PND 4 pups were similar to CV ranges of older pups and adult rats

Best Practices for In-life Thyroid Hormone Sampling

- Laboratories should validate thyroid hormone measurements across life stages; confirm sufficient dynamic range
 - Include 'across assay' controls
 - Positive control data
 - Compile a historical control database
 - Report variance
 - OECD TG 407 (28 day):
 - CV < 25% for total T4 and total T3
 - CV < 35% for TSH
 - EPA 890.1450/1500 (pubertal assays)
 - CV ≤ 27.5% (♂) and 29.4% (♀) for total T4
 - CV ≤ 58.3% for TSH

Conclusions

- Thyroid endpoints should be examined using a weight of evidence approach
 - Some study types evaluate isolated ages or variable thyroid endpoints
 - Comparison of thyroid hormone data across laboratories can be difficult
- Thyroid hormone assessments in young animals
 - Volume limitations: pool blood by litter
 - Method sensitivity/dynamic range should be considered
- Impact of experimental parameters on thyroid hormone variability has not been systematically evaluated
- Early indicator: Within a lab, variability may be similar across ages
- Validate thyroid hormone assays across life stages
 - Be prepared to address issues related to variability